

# HiPerFAST™ IGBT with Fast Diode

IXGH 50N90B2D1  
IXGK 50N90B2D1  
IXGX 50N90B2D1

$V_{CES}$  = 900 V  
 $I_{C25}$  = 75 A  
 $V_{CE(sat)}$  = 2.7 V  
 $t_{fi typ}$  = 200 ns

## B2-Class High Speed IGBT with Fast Diode

Preliminary Data Sheet



Symbol	Test Conditions	Maximum Ratings	
$V_{CES}$	$T_J = 25^\circ\text{C}$ to $150^\circ\text{C}$	900	V
$V_{CGR}$	$T_J = 25^\circ\text{C}$ to $150^\circ\text{C}$ ; $R_{GE} = 1\text{ M}\Omega$	900	V
$V_{GES}$	Continuous	$\pm 20$	V
$V_{GEM}$	Transient	$\pm 30$	V
$I_{C25}$	$T_C = 25^\circ\text{C}$ (limited by leads)	75	A
$I_{C110}$	$T_C = 110^\circ\text{C}$	50	A
$I_{CM}$	$T_C = 25^\circ\text{C}$ , 1 ms	200	A
<b>SSOA</b> <b>(RBSOA)</b>	$V_{GE} = 15\text{ V}$ , $T_{VJ} = 125^\circ\text{C}$ , $R_G = 10\ \Omega$ Clamped inductive load @ $\leq 600\text{V}$	$I_{CM} = 100$	A
$P_C$	$T_C = 25^\circ\text{C}$	400	W
$T_J$		-55 ... +150	$^\circ\text{C}$
$T_{JM}$		150	$^\circ\text{C}$
$T_{stg}$		-55 ... +150	$^\circ\text{C}$
Maximum lead temperature for soldering 1.6 mm (0.062 in.) from case for 10 s		300	$^\circ\text{C}$
$M_d$	Mounting torque (TO-247, TO-264)	1.13/10Nm/lb.in.	
$F_C$	Mounting force (PLUS247)	20..120 / 4.5..25	N/lb
<b>Weight</b>		TO-247	6 g
		TO-264	10 g
		PLUS247	6 g

TO-247 (IXGH)

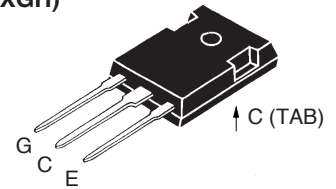

PLUS247 (IXGX)

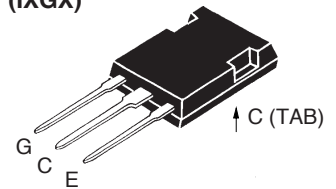

TO-264 (IXGK)

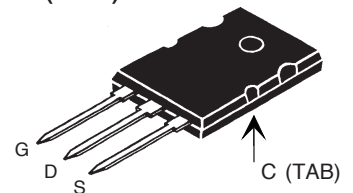

G = Gate      C = Collector  
E = Emitter    TAB = Collector

### Features

- High frequency IGBT
- High current handling capability
- MOS Gate turn-on  
- drive simplicity

### Applications

- PFC circuits
- Uninterruptible power supplies (UPS)
- Switched-mode and resonant-mode power supplies
- AC motor speed control
- DC servo and robot drives
- DC choppers

### Advantages

- High power density
- Very fast switching speeds for high frequency applications

Symbol	Test Conditions ( $T_J = 25^\circ\text{C}$ unless otherwise specified)	Characteristic Values		
		min.	typ.	max.
$V_{GE(th)}$	$I_C = 250\ \mu\text{A}$ , $V_{CE} = V_{GE}$	3.0		5.0 V
$I_{CES}$	$V_{CE} = V_{CES}$ $V_{GE} = 0\text{ V}$ $T_J = 150^\circ\text{C}$			50 $\mu\text{A}$ 1 mA
$I_{GES}$	$V_{CE} = 0\text{ V}$ , $V_{GE} = \pm 20\text{ V}$			$\pm 100\text{ nA}$
$V_{CE(sat)}$	$I_C = I_{C110}$ , $V_{GE} = 15\text{ V}$ , Note 1 $T_J = 125^\circ\text{C}$	2.2	2.7	V V

Symbol	Test Conditions ( $T_J = 25^\circ\text{C}$ unless otherwise specified)	Characteristic Values		
		min.	typ.	max.
$g_{fs}$	$I_C = I_{C110}; V_{CE} = 10\text{ V}$ , Note 1	25	40	S
$C_{ies}$	$V_{CE} = 25\text{ V}$ , $V_{GE} = 0\text{ V}$ , $f = 1\text{ MHz}$		2500	pF
$C_{oes}$			205	pF
$C_{res}$			75	pF
$Q_g$	$I_C = I_{C110}$ , $V_{GE} = 15\text{ V}$ , $V_{CE} = 0.5 V_{CES}$		135	nC
$Q_{ge}$			23	nC
$Q_{gc}$			50	nC
$t_{d(on)}$	<b>Inductive load</b> $I_C = I_{C110}$ , $V_{GE} = 15\text{ V}$ $V_{CE} = 720\text{ V}$ , $R_G = R_{off} = 5\ \Omega$		20	ns
$t_{ri}$			28	ns
$t_{d(off)}$			350	500 ns
$t_{fi}$			200	ns
$E_{off}$			4.7	7.5 mJ
$t_{d(on)}$		<b>Inductive load, <math>T_J = 125^\circ\text{C}</math></b> $I_C = I_{C110}$ , $V_{GE} = 15\text{ V}$ $V_{CE} = 720\text{ V}$ , $R_G = R_{off} = 5\ \Omega$		20
$t_{ri}$			28	ns
$E_{on}$			1.5	mJ
$t_{d(off)}$			400	ns
$t_{fi}$			420	ns
$E_{off}$			8.7	mJ
$R_{thJC}$			0.31	K/W
$R_{thCH}$		0.21		K/W

**Diode**

Symbol	Conditions	Maximum Ratings	
$I_{F25}$	$T_C = 115^\circ\text{C}$	30	A

Symbol	Conditions ( $T_J = 25^\circ\text{C}$ unless otherwise specified)	Characteristic Values		
		min.	typ.	max.
$V_F$	$I_F = 30\text{ A}$ ; Note 1 $T_{VJ} = 150^\circ\text{C}$		2.5	2.75 V
			1.8	V
$I_{RM}$	$I_F = 10\text{ A}$ ; $di_F/dt = -100\text{ A}/\mu\text{s}$ ; $T_{VJ} = 100^\circ\text{C}$ $V_R = 100\text{ V}$ ; $V_{GE} = 0\text{ V}$		5.5	11.5 A
$t_{rr}$			200	ns
$R_{thJC}$	with heat transfer paste		0.25	0.9 K/W
$R_{thCH}$				K/W

Note 1: Pulse test,  $t \leq 300\ \mu\text{s}$ , duty cycle  $\leq 2\%$

IXYS reserves the right to change limits, test conditions, and dimensions.

IXYS MOSFETs and IGBTs are covered by one or more of the following U.S. patents:	4,835,592	4,931,844	5,049,961	5,237,481	6,162,665	6,404,065 B1	6,683,344	6,727,585
	4,850,072	5,017,508	5,063,307	5,381,025	6,259,123 B1	6,534,343	6,710,405 B2	6,759,692
	4,881,106	5,034,796	5,187,117	5,486,715	6,306,728 B1	6,583,505	6,710,463	6,771,478 B2

**Fig. 1. Output Characteristics**  
@ 25 °C

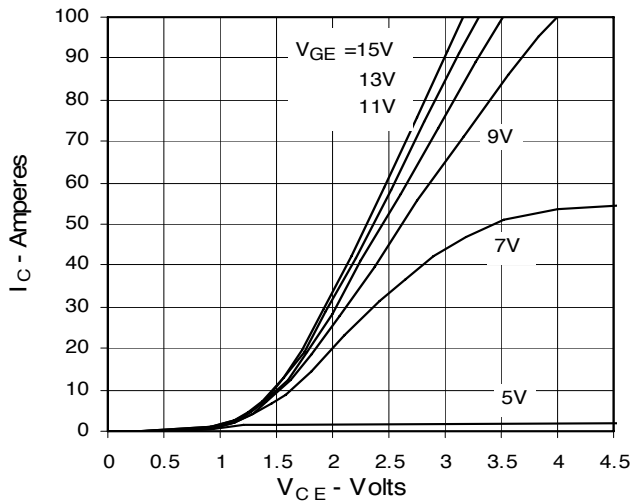

**Fig. 2. Extended Output Characteristics**  
@ 25 °C

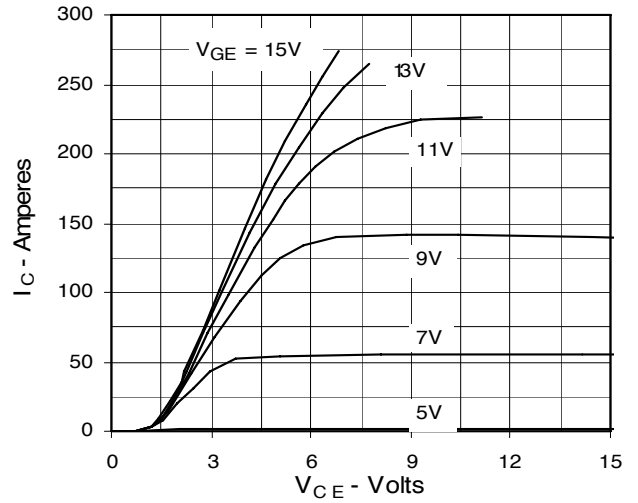

**Fig. 3. Output Characteristics**  
@ 125 °C

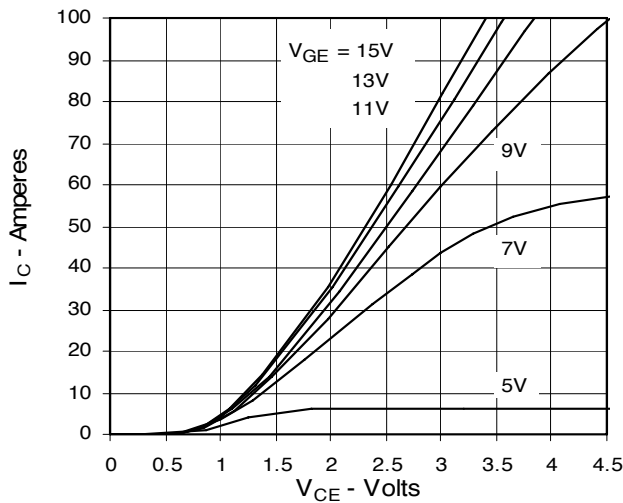

**Fig. 4. Dependence of  $V_{CE(sat)}$  on Temperature**

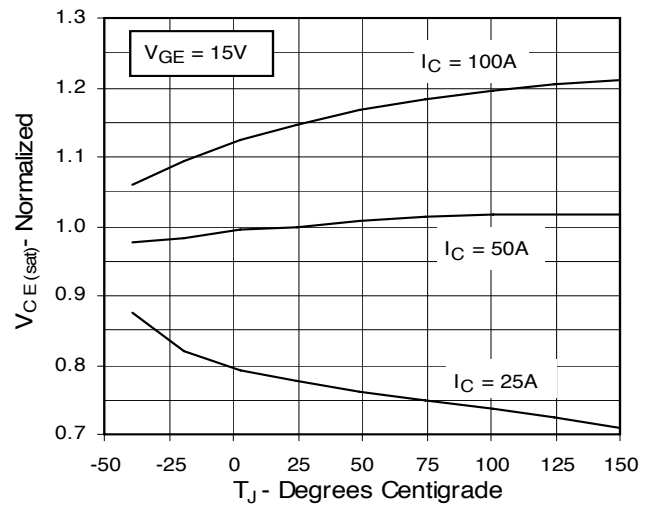

**Fig. 5. Collector-to-Emitter Voltage vs. Gate-to-Emitter voltage**

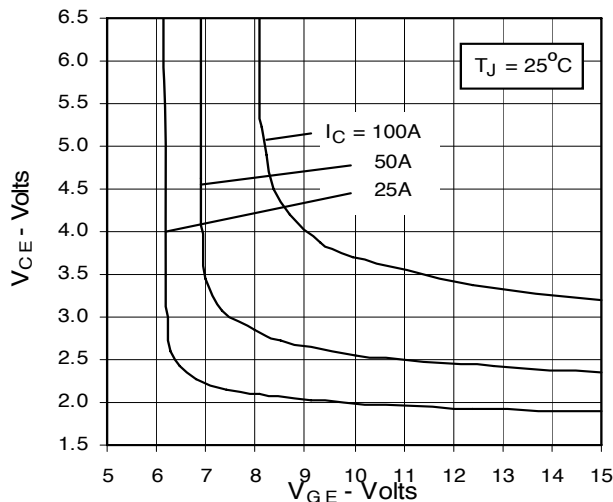

**Fig. 6. Input Admittance**

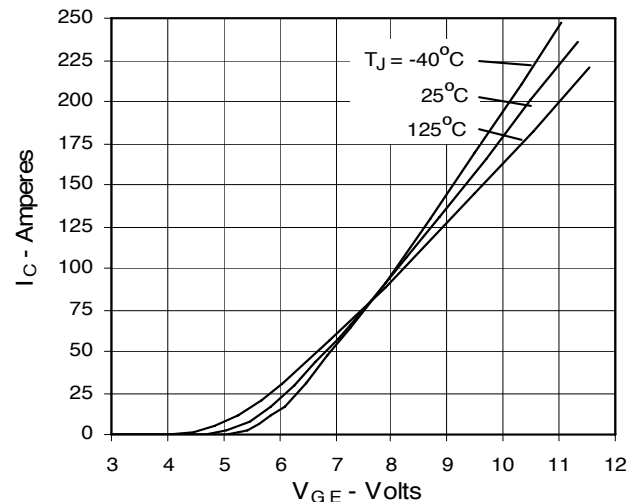

**Fig. 7. Transconductance**

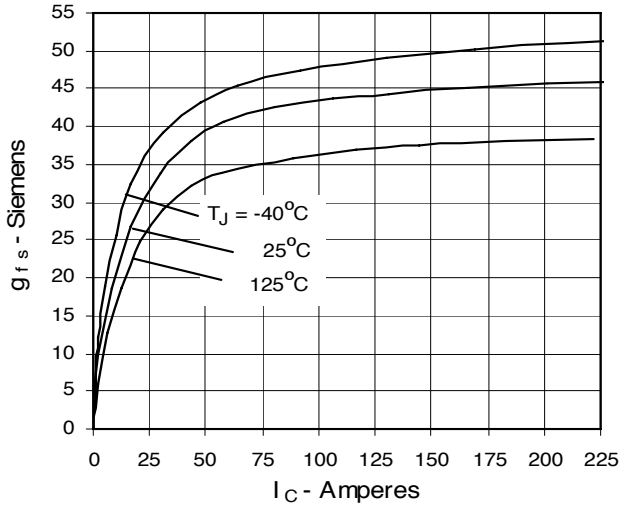

**Fig. 8. Dependence of Turn-off Energy Loss on  $R_G$**

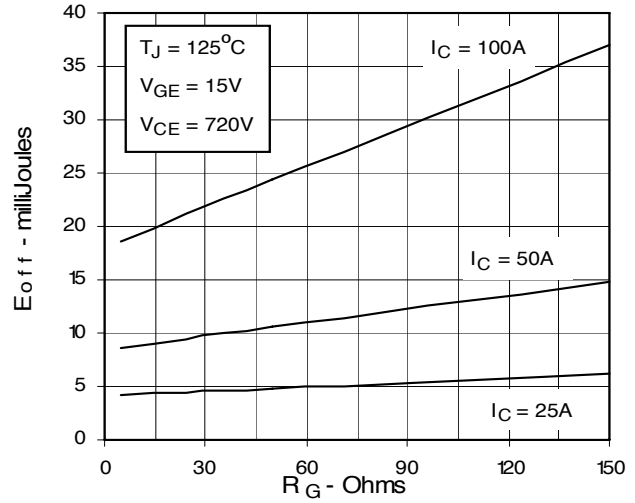

**Fig. 9. Dependence of Turn-Off Energy Loss on  $I_C$**

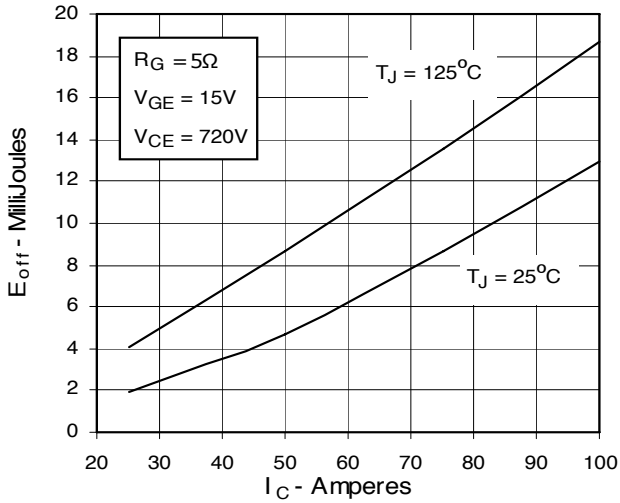

**Fig. 10. Dependence of Turn-off Energy Loss on Temperature**

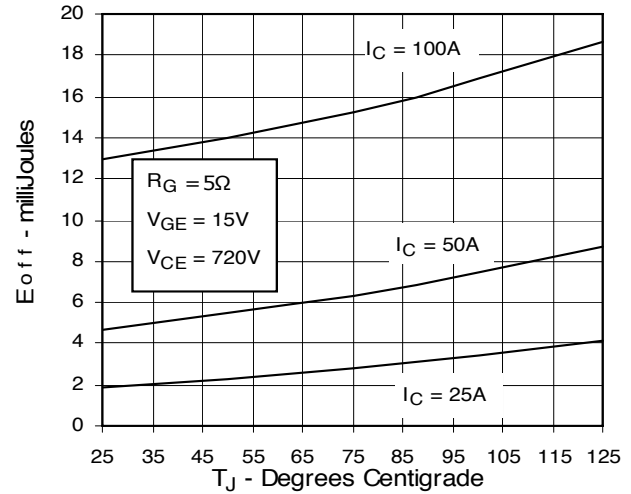

**Fig. 11. Dependence of Turn-off Switching Time on  $R_G$**

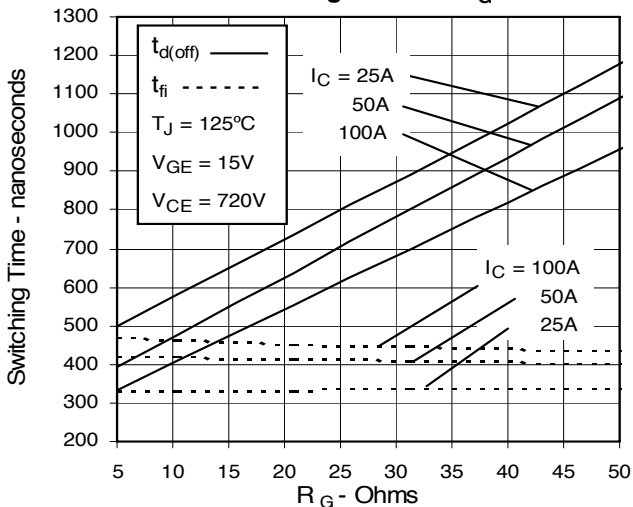

**Fig. 12. Dependence of Turn-off Switching Time on  $I_C$**

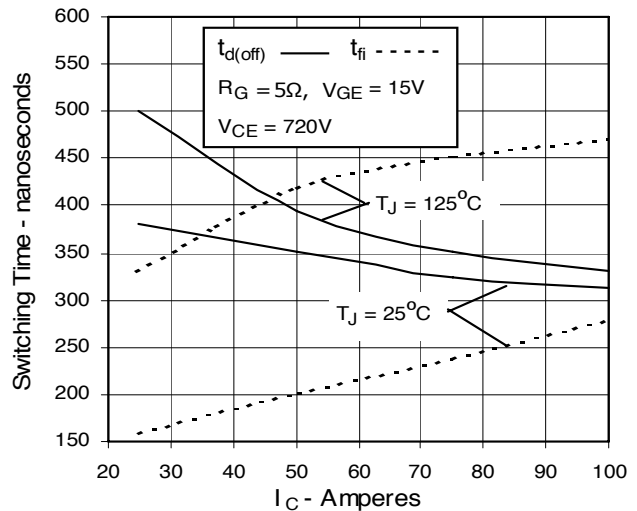

**Fig. 13. Dependence of Turn-off Switching Time on Temperature**

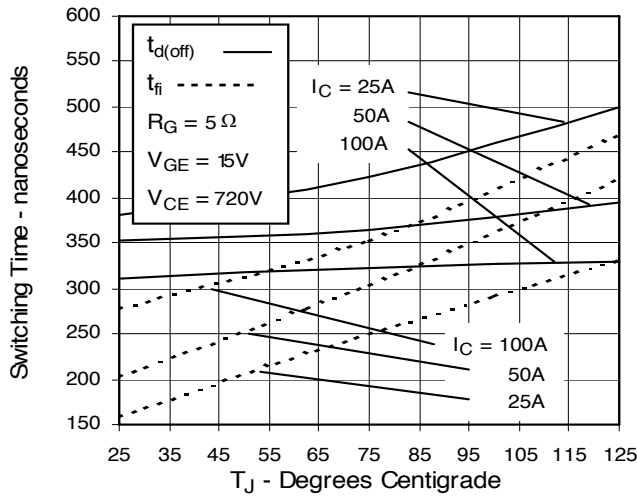

**Fig. 14. Gate Charge**

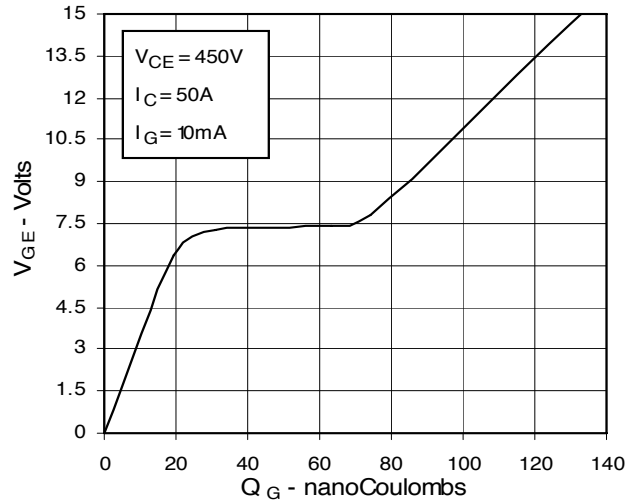

**Fig. 15. Capacitance**

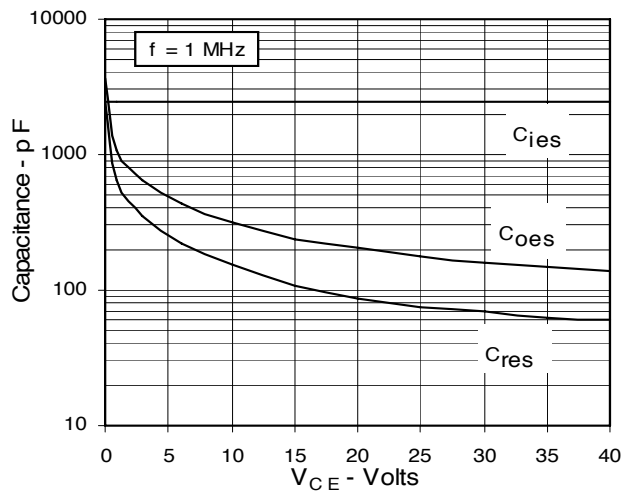

**Fig. 16. Reverse-Bias Safe Operating Area**

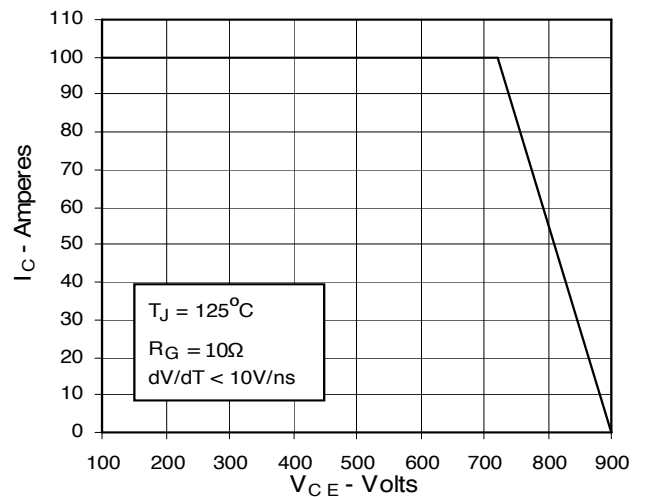

**Fig. 17. Maximum Transient Thermal Resistance**

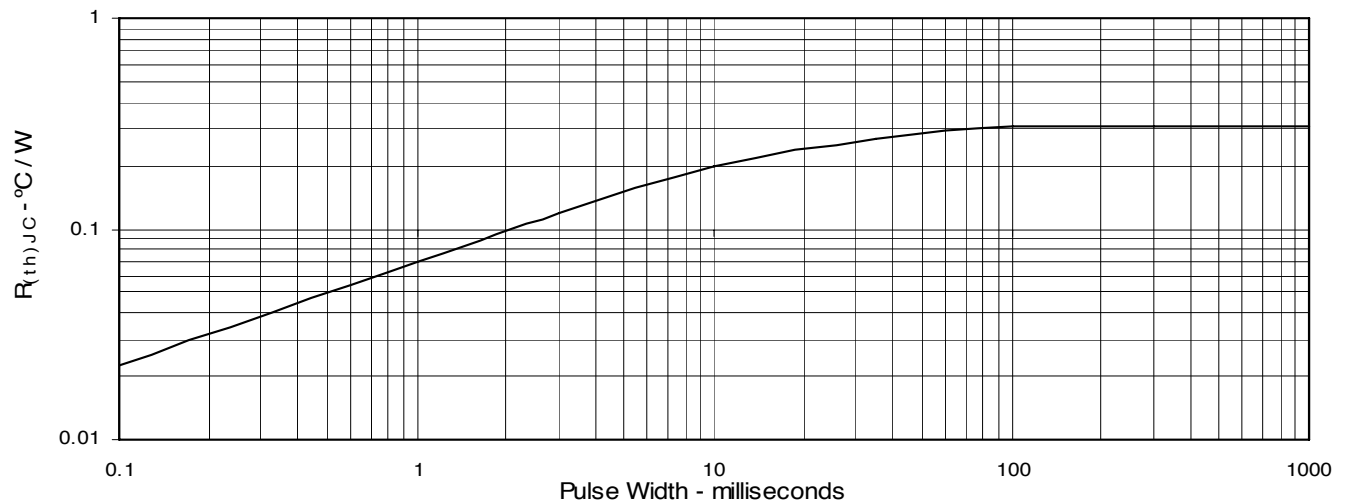

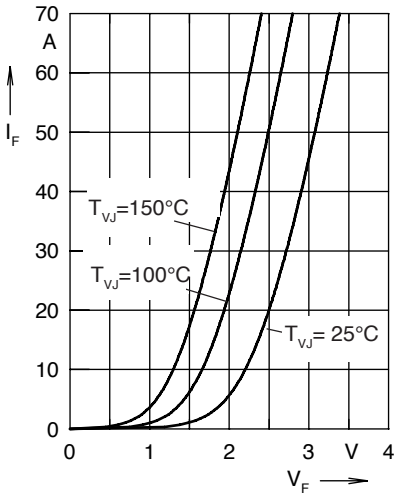

Fig. 18. Forward current  $I_F$  versus  $V_F$

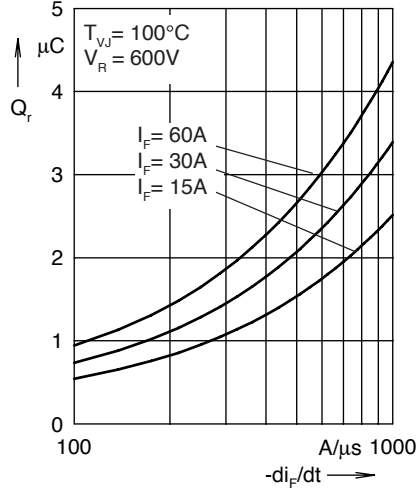

Fig. 19. Reverse recovery charge  $Q_r$  versus  $-di_F/dt$

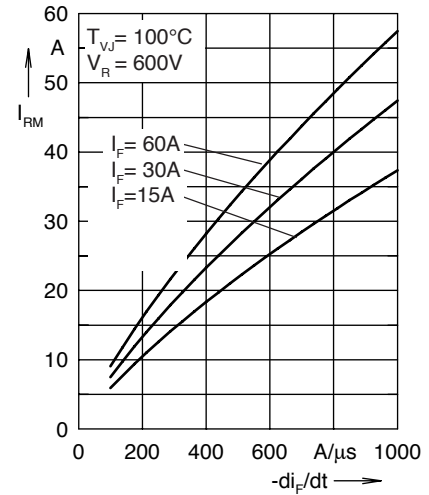

Fig. 20. Peak reverse current  $I_{RM}$  versus  $-di_F/dt$

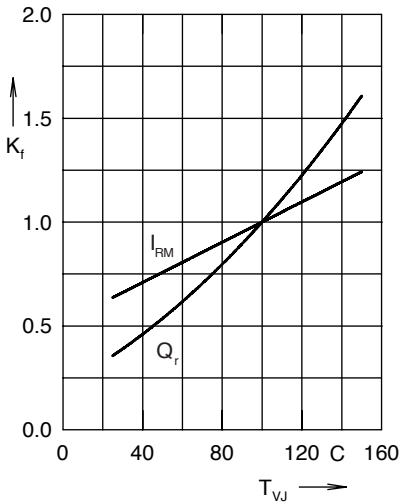

Fig. 21. Dynamic parameters  $Q_r$ ,  $I_{RM}$  versus  $T_{VJ}$

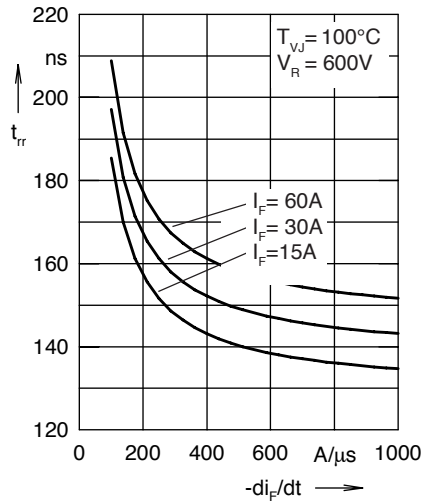

Fig. 22. Recovery time  $t_{rr}$  versus  $-di_F/dt$

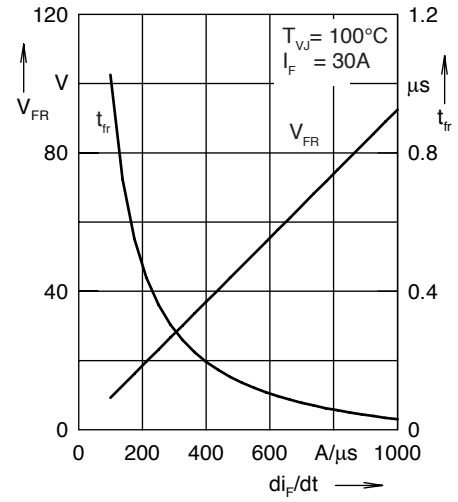

Fig. 23. Peak forward voltage  $V_{FR}$  and  $t_{fr}$  versus  $di_F/dt$

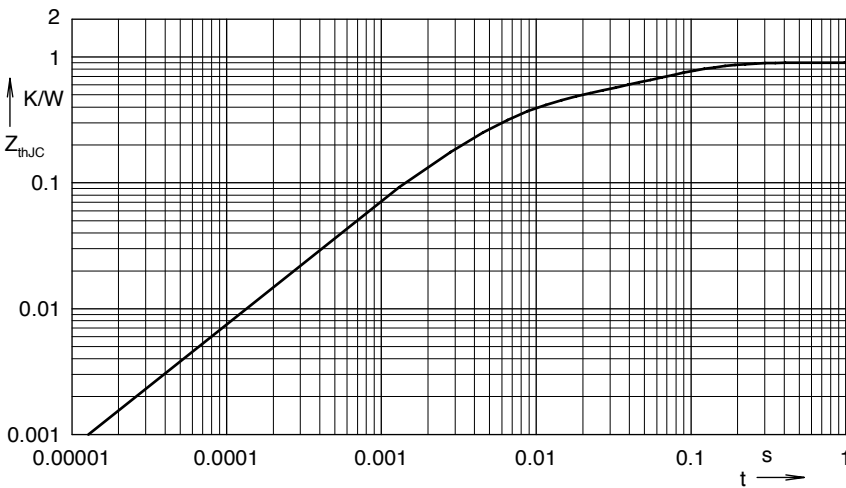

Fig. 24 Transient thermal resistance junction to case

Constants for  $Z_{thJC}$  calculation:

i	$R_{thi}$ (K/W)	$t_i$ (s)
1	0.465	0.0052
2	0.179	0.0003
3	0.256	0.0397

## Package Outlines

### TO-247 AD Outline

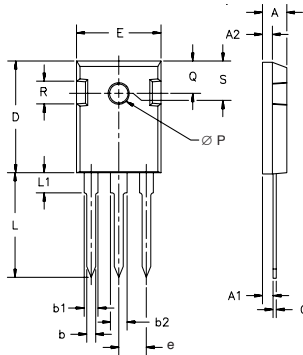

Dim.	Millimeter		Inches	
	Min.	Max.	Min.	Max.
A	4.7	5.3	.185	.209
A <sub>1</sub>	2.2	2.54	.087	.102
A <sub>2</sub>	2.2	2.6	.059	.098
b	1.0	1.4	.040	.055
b <sub>1</sub>	1.65	2.13	.065	.084
b <sub>2</sub>	2.87	3.12	.113	.123
C	.4	.8	.016	.031
D	20.80	21.46	.819	.845
E	15.75	16.26	.610	.640
e	5.20	5.72	0.205	0.225
L	19.81	20.32	.780	.800
L1		4.50		.177
∅P	3.55	3.65	.140	.144
Q	5.89	6.40	0.232	0.252
R	4.32	5.49	.170	.216
S	6.15	BSC	.242	BSC

### PLUS 247™ Outline

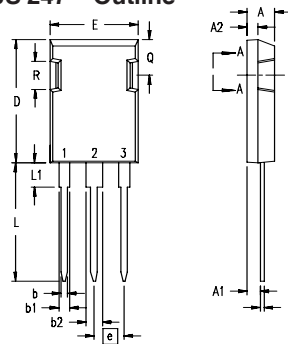

Dim.	Millimeter		Inches	
	Min.	Max.	Min.	Max.
A	4.83	5.21	.190	.205
A <sub>1</sub>	2.29	2.54	.090	.100
A <sub>2</sub>	1.91	2.16	.075	.085
b	1.14	1.40	.045	.055
b <sub>1</sub>	1.91	2.13	.075	.084
b <sub>2</sub>	2.92	3.12	.115	.123
C	0.61	0.80	.024	.031
D	20.80	21.34	.819	.840
E	15.75	16.13	.620	.635
e	5.45	BSC	.215	BSC
L	19.81	20.32	.780	.800
L1	3.81	4.32	.150	.170
Q	5.59	6.20	.220	0.244
R	4.32	4.83	.170	.190

### TO-264 AA Outline

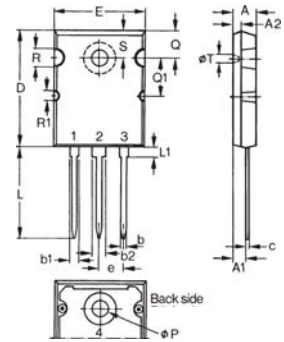

Dim.	Millimeter		Inches	
	Min.	Max.	Min.	Max.
A	4.82	5.13	.190	.202
A <sub>1</sub>	2.54	2.89	.100	.114
A <sub>2</sub>	2.00	2.10	.079	.083
b	1.12	1.42	.044	.056
b <sub>1</sub>	2.39	2.69	.094	.106
b <sub>2</sub>	2.90	3.09	.114	.122
c	0.53	0.83	.021	.033
D	25.91	26.16	1.020	1.030
E	19.81	19.96	.780	.786
e	5.46	BSC	.215	BSC
J	0.00	0.25	.000	.010
K	0.00	0.25	.000	.010
L	20.32	20.83	.800	.820
L1	2.29	2.59	.090	.102
P	3.17	3.66	.125	.144
Q	6.07	6.27	.239	.247
Q1	8.38	8.69	.330	.342
R	3.81	4.32	.150	.170
R1	1.78	2.29	.070	.090
S	6.04	6.30	.238	.248
T	1.57	1.83	.062	.072

Terminals: 1 - Gate  
 2 - Drain (Collector)  
 3 - Source (Emitter)  
 4 - Drain (Collector)

### PRELIMINARY TECHNICAL INFORMATION

The product presented herein is under development. The Technical Specifications offered are derived from data gathered during objective characterizations of preliminary engineering lots; but also may yet contain some information supplied during a subjective pre-production design evaluation. IXYS reserves the right to change limits, test conditions, and dimensions without notice.